



2018

SCNC

SKILLS CANADA
NATIONAL COMPETITION

OCMT

OLYMPIADES CANADIENNES
DES MÉTIERS ET
DES TECHNOLOGIES



skillsCompétences
Canada
Edmonton2018

PROJET D'ÉPREUVE / TEST PROJECT

CONTRÔLE INDUSTRIEL INDUSTRIAL CONTROL

NIVEAUX POSTSECONDAIRE /
POST - SECONDARY

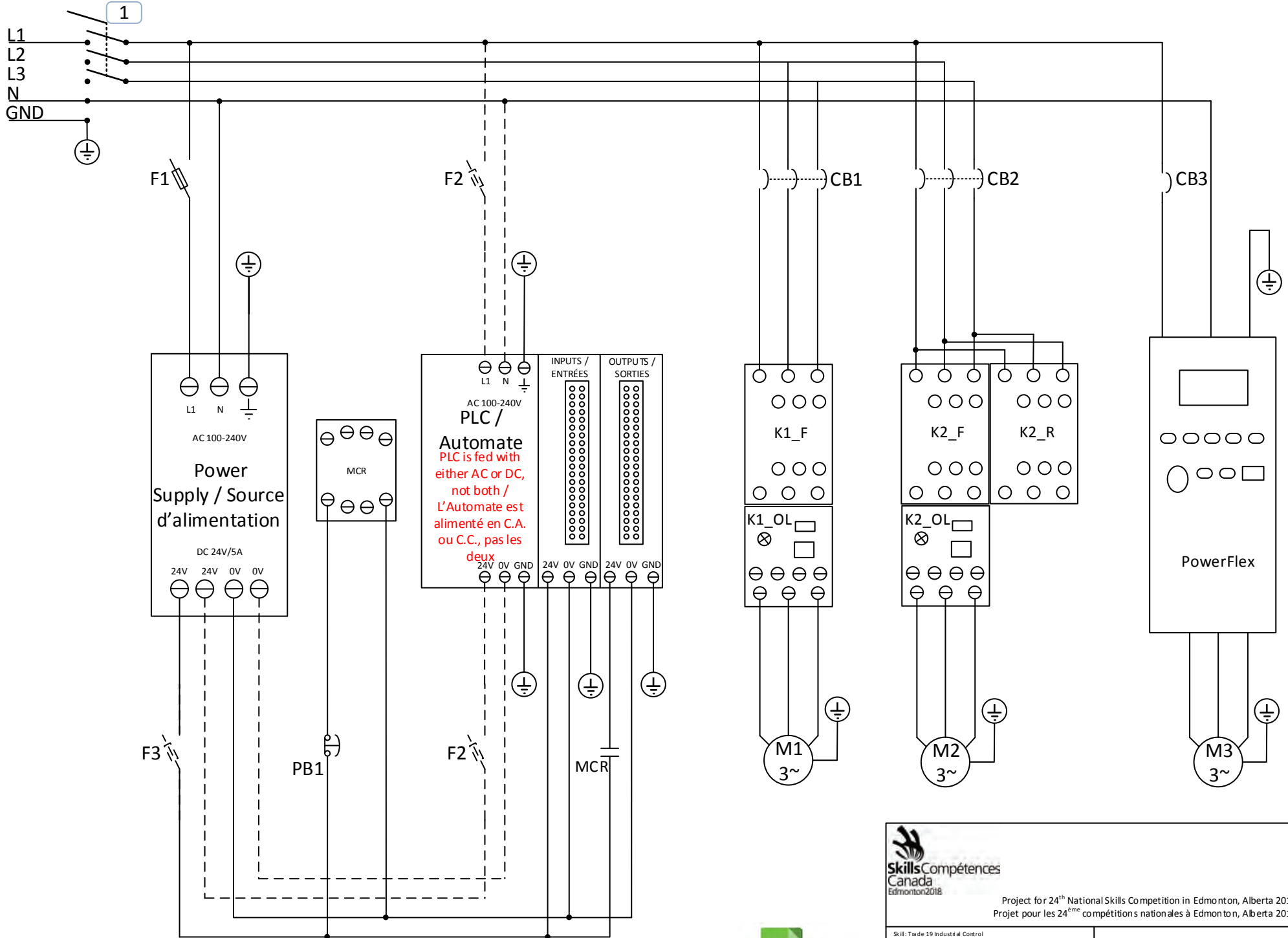



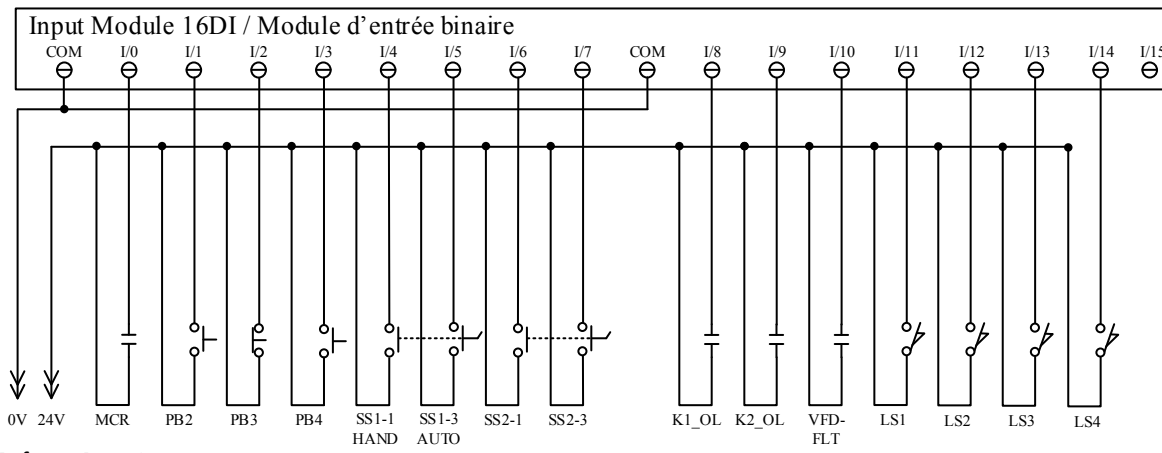

Refer to Page 1
Se référer à la page 1

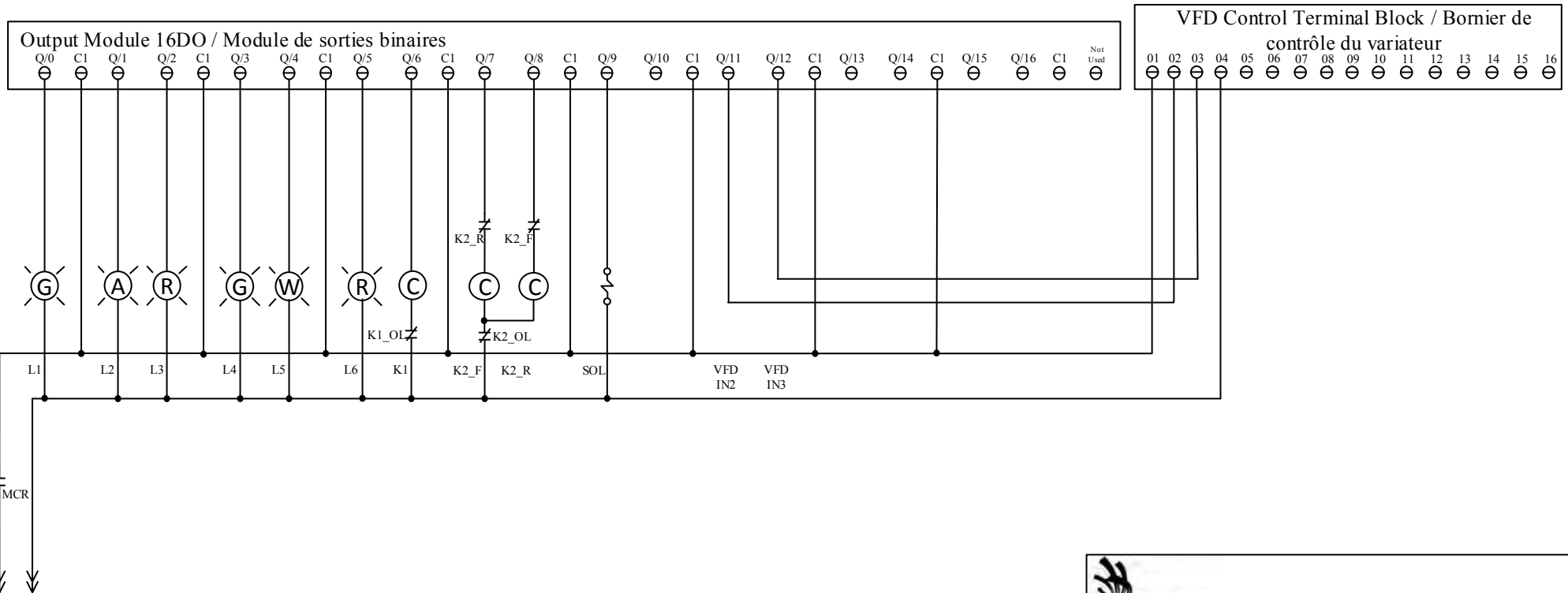

Refer to Page 1
Se référer à la page 1



		Project for 24 th National Skills Competition in Edmonton, Alberta 2018 Projet pour les 24 ^{ème} compétitions nationales à Edmonton, Alberta 2018	
Skill: Trade 19 Industrial Control Compétence: Métier 19 Contrôle Industriel		Control Layout / Schémas de contrôle	
Scale / Échelle : Not to Scale / Aucune			
Date: June 2018 / Juin 2018			
Designer / Concepteur: 2018 Trade 19 NTC / CNT métier 19 2018		Rev: 4.0 (2017-Dec-08)	Page: 2 / 5

Back plate suggested layout / Disposition proposée de la plaque de montage

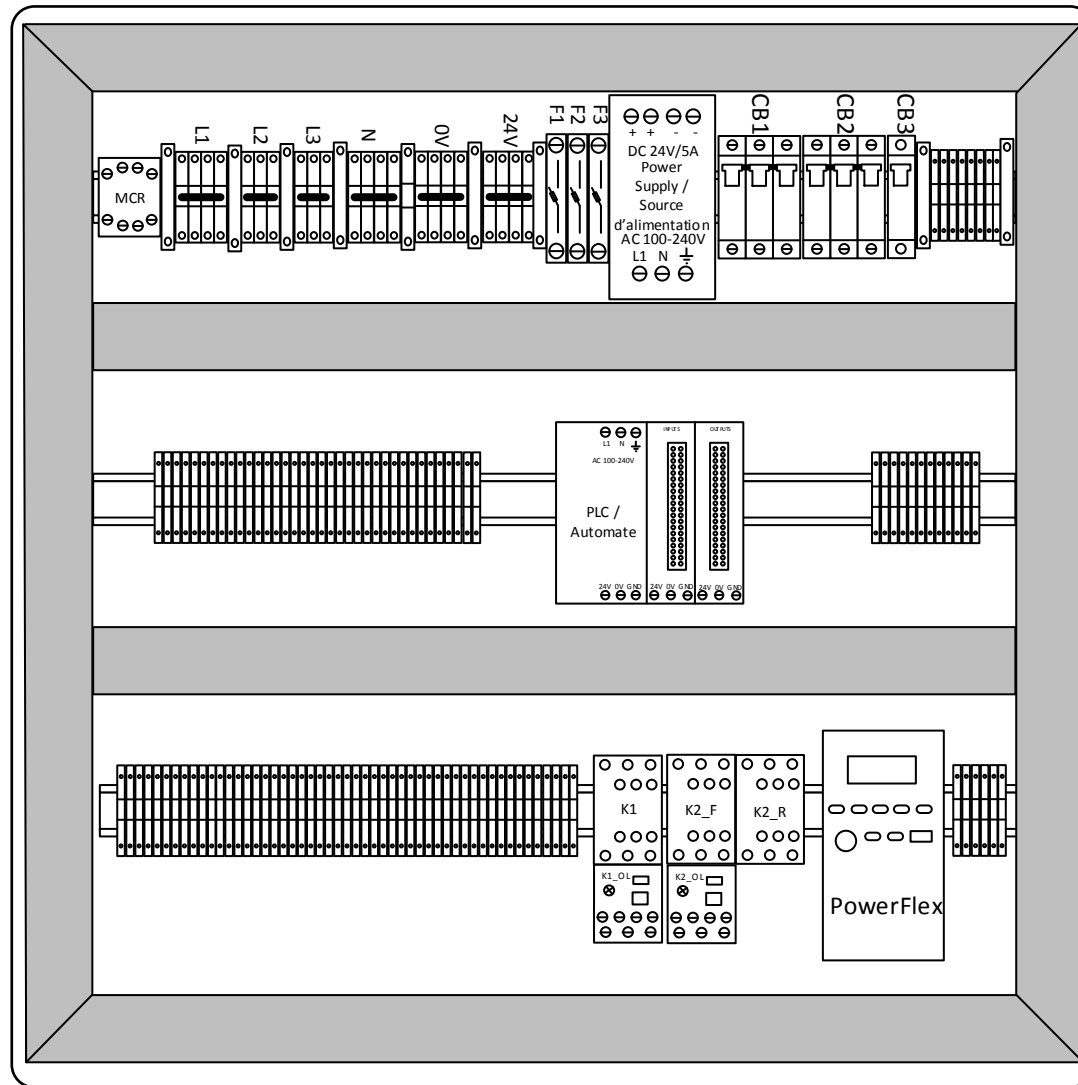

UTILISATION DE DOCUMENTS



Project for 24th National Skills Competition in Edmonton, Alberta 2018
 Projet pour les 24^{ème} compétitions nationales à Edmonton, Alberta 2018

Skill: Trade 19 Industrial Control
 Compétence: Métier 19 Contrôle industriel

Scale / Échelle: Not to Scale / Aucune

Date: June 2018 / Juin 2018

Designer / Concepteur: 2018 Trade 19 NTC / CNT métier 19 2018

**Back Panel Layout /
 Disposition de la plaque de
 montage**

Rev: 4.0 (2017-Dec-08)

Page: 3 / 5

Left Side View / Vue du côté gauche

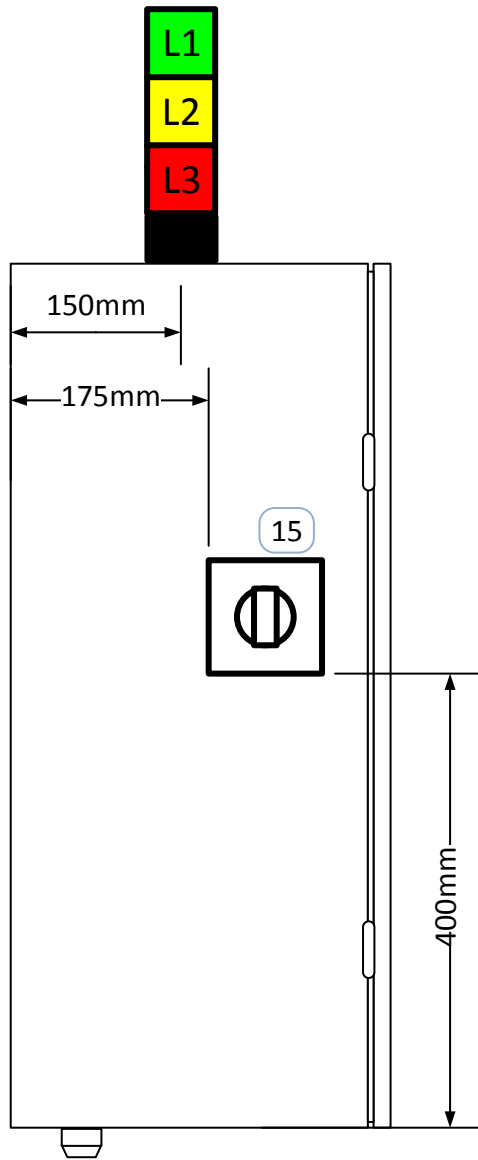

Front View / Vue de façade

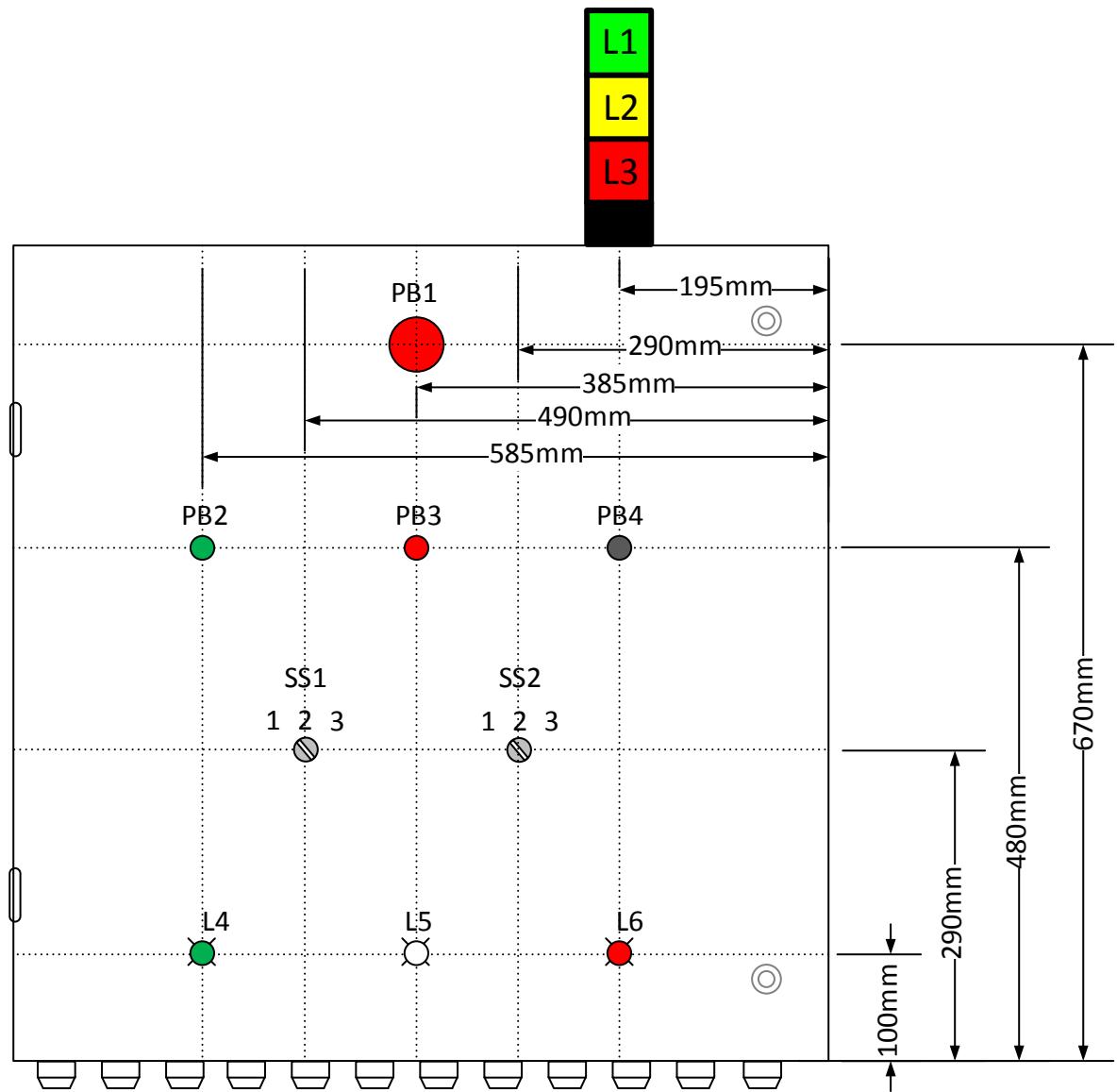

Project for 24th National Skills Competition in Edmonton, Alberta 2018
 Projet pour les 24^{ème} compétitions nationales à Edmonton, Alberta 2018

Skill: Trade 19 Industrial Control Compétence: Métier 19 Contrôle industriel
Scale / Échelle: Not to Scale / Aucune
Date: June 2018 / Juin 2018
Designer / Concepteur: 2018 Trade 19 NTC / CNT métier 19 2018

Door Layout / Disposition
de la porte



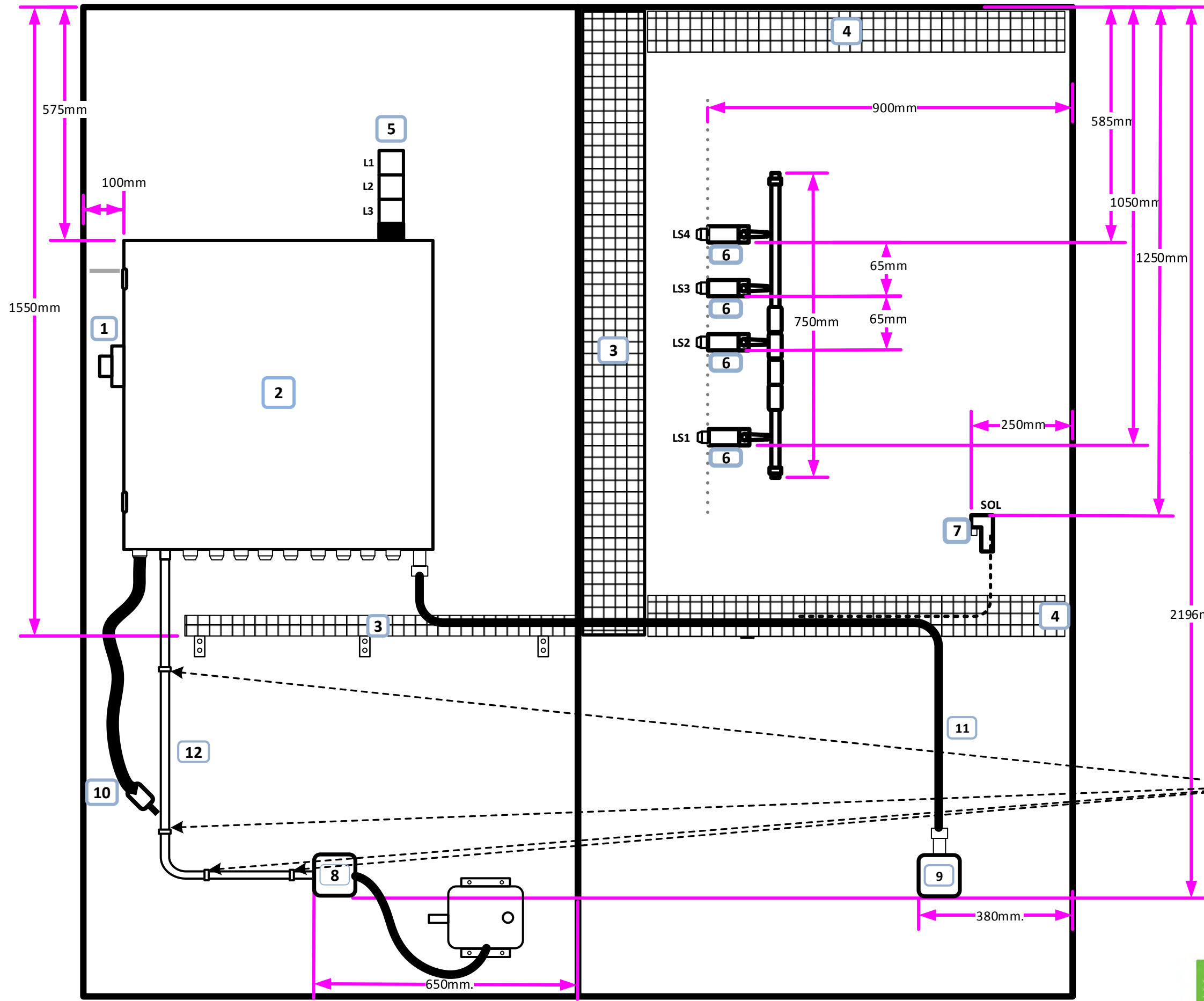

1. Panel Mounted Disconnect / Sectionneur monté en surface
2. Control Cabinet / Armoire de contrôle
3. 6" Wide Wire Basket Tray / Chemin de câble de 6po
4. 4" Wide Wire Basket Tray / Chemin de câble de 4po
5. Stack Light / Tour lumineuse
6. Limit Switch / Interrupteur de fin de course
7. Solenoid Valve / Soupape Solénoïde
8. Junction Box (M3) / Boîte de jonction (M3)
9. Junction Box (M1) / Boîte de jonction (M1)
10. 120V Cheater cord / Cordon d'alimentation 120V
11. TECK90 cable / Câble TECK90
12. ½" EMT conduit / Conduit EMT ½po

All measurements will be taken from where it is shown on the drawing on the flat portion of device, if no dimension is given it is at installer's discretion / Les mesures doivent être prises où le dessin l'indique sur la partie plate des composants, si aucune mesure n'est indiquée elle est laissée à la discrétion de l'installateur

