



Project

Mobile Robotics

SECONDARY

Jeu de Tire D'érable (Maple Taffy Game)

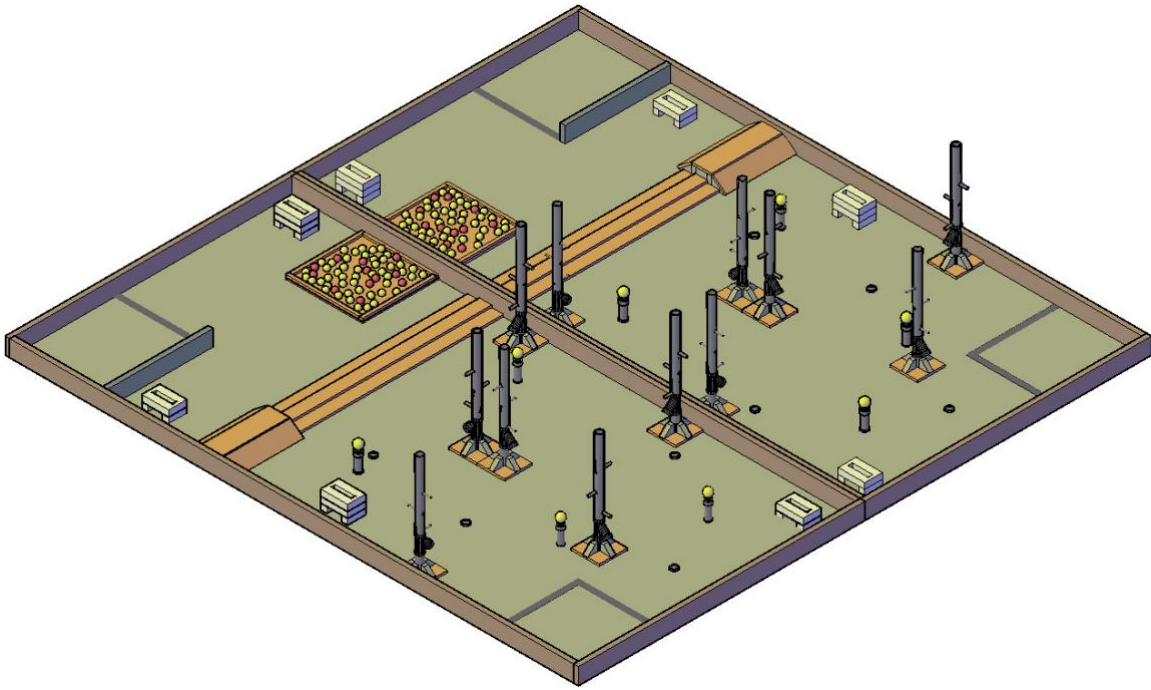

Project Document
23 - Mobile Robotics
Secondary Level

Table of Contents

1. TERMS.....	3
2. SAFETY	4
3. OVERVIEW, GAME DESCRIPTION, AND PLAY	5
4. TEAM’S AREA AND COURT AREAS	10
5. DETAILED GAME COMPONENTS.....	18
6. MAPLE TAFFY GAME SCORING SUMMARY	27
7. PIT AREA AND COURT ACCESS.....	29
8. ROBOT RESTRICTIONS.....	31
9. INSPECTION	34
10. AUTONOMOUS COMPETITION OVERVIEW	37
11. MEDAL AWARDING SYSTEM.....	39
APPENDIX A: COURT DIMENSIONS AND DETAILS.....	40
APPENDIX B: TELE-OPERATED MAIN GAME SCORE SHEET	40
APPENDIX C: SAMPLE WIRING DIAGRAMS.....	40
APPENDIX D: APPROVED AUTONOMOUS CHALLENGE CHASSIS OPTIONAL PRE-BUILD.....	40
APPENDIX E: SAFETY CRITERIA AND SCORESHEET FOR JUDGING	40
APPENDIX F: INSPECTION SHEET.....	40

1. Terms

- 1.1. Tele-Operated Robot Elements are elements under the direct/active control of competitors during game play using one or two radios/game controllers held by the courtside competitors.
- 1.2. Independent Autonomous Elements are elements not under the direct control of competitors throughout gameplay.
 - 1.2.1. The only permitted direct competitor interaction with these elements is initiation of the autonomous device at the beginning of the game.
 - 1.2.2. Once the expiration of the time has been complete, these devices must be turned off safely. This may be done by the NTC/Judges.
 - 1.2.3. Mobile Independent Autonomous Elements are considered any autonomous element that moves about the court.
 - 1.2.4. Stationary Independent Autonomous Elements are considered any autonomous element that does not move about the court.
 - 1.2.4.1. This includes elements that have electrical components as well as elements that do not contain electrical components.
 - 1.2.5. Independent Autonomous Elements may interact with the team's tele-operated mobile robot.
 - 1.2.5.1. Tele-operated mobile robots may initiate an active response by the Independent Autonomous Element which may be managed by a mechanical based system or a pre-programmed system internal to the Independent Autonomous Element.

2. Safety

- 2.1. Safety is of paramount importance in all aspects of the competition.
 - 2.1.1. All individuals on site are expected to be mindful and ensure they act safely at all times.
- 2.2. Specific expectations with regards to the Robotics competition are as follows:
 - 2.2.1. All individuals are expected to wear eye protection at all times when they are in the competition area.
 - 2.2.2. Teams are expected to ensure their pit area is tidy.
 - 2.2.3. All fabrication work involving material removal processes (grinding / cutting) must be completed in the designated “Grinding Booth” area.
 - 2.2.4. All competitors must ensure they are not wearing any jewelry that could be caught in something.
 - 2.2.5. All competitors must ensure their hair is tied back/not in their eyes, and not able to be caught in anything.
 - 2.2.6. All individuals are expected to ensure all trip hazards are reduced as much as possible.
 - 2.2.6.1. In situations where trip hazards cannot be eliminated, appropriate signage and notification must be made to everyone in the area.
 - 2.2.7. All individuals are expected to ensure they are wearing appropriate footwear.
 - 2.2.7.1. All footwear must be closed toe.
 - 2.2.7.2. All laces must be tied.
 - 2.2.8. All Robots must pass a safety inspection (details in Section 9).
- 2.3. Safety Scoring criteria details are available in Appendix E.

3. Overview, Game Description, and Play

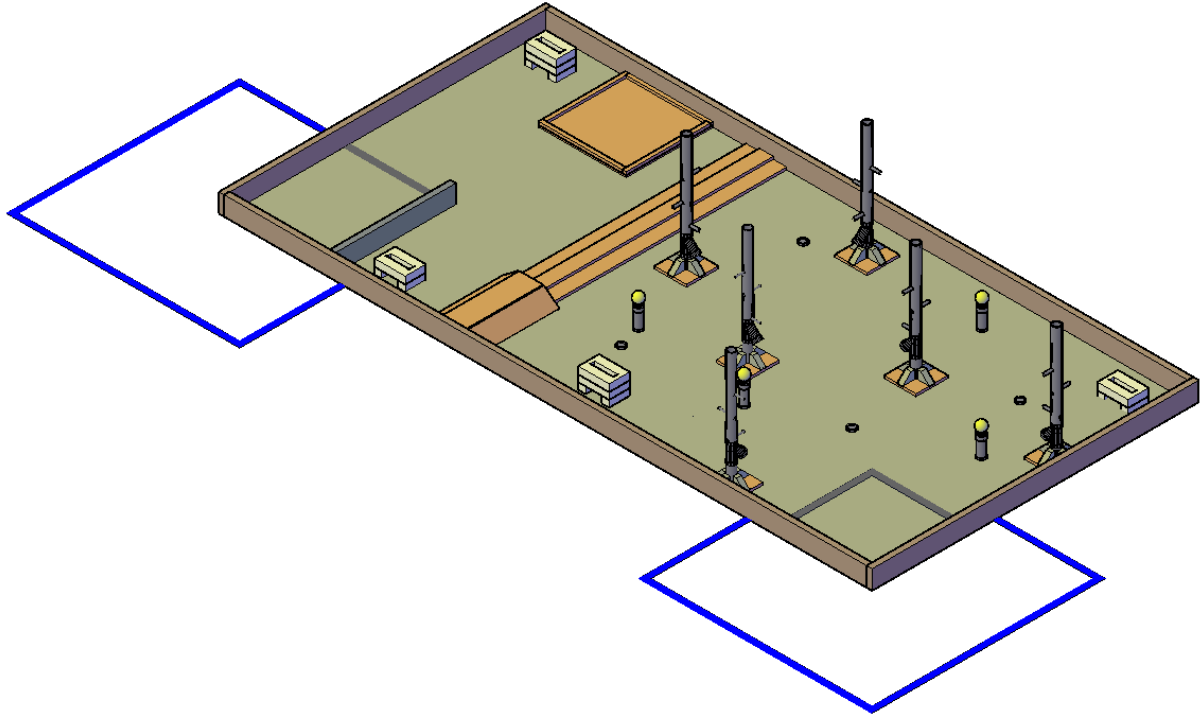

Figure: Overall Team Court

3.1. General Overview

- 3.1.1. The core game situation requires a Robot or Robots to use the components provided in their Exclusive Use Court Space to:
 - 3.1.1.1. Harvest the “Sap” from the “Maple Trees”
 - 3.1.1.2. “Refine” the sap into “Maple Syrup”
 - 3.1.1.3. Gather and move the “Snow Piles” into a designated location
 - 3.1.1.4. Deposit the “Maple Syrup” onto the “Snow Piles” to make “Maple Taffy”
- 3.1.2. The goal of this game is for Robot(s) to gather and process “Sap” from “Maple Trees”, creating “Maple Taffy” on “Snow Piles”.
- 3.1.3. Teams will earn points for:
 - 3.1.3.1. Moving the “Snow Piles” to the designated area
 - 3.1.3.2. Harvesting and processing the “Sap”, and delivering the “Sap” to the appropriate location
 - 3.1.3.3. Depositing processed “Maple Sap” onto the “Snow Piles” (in the appropriate location) making “Maple Taffy”

3.2. Game Description

- 3.2.1. Games will involve two teams at a time.
- 3.2.2. Competitors must remain in their designated driver zone on their side of the court.
- 3.2.3. Teams can utilize a maximum of TWO tele-operated robots.
- 3.2.4. Teams may also use a maximum of ONE Independent Autonomous Element as part of their entry.
 - 3.2.4.1. This must start and remain in the designated autonomous zone.
- 3.2.5. At no time shall a team's Robots (Tele-operated or Autonomous) interact or interfere with their opponents, or their opponents' Robots.
 - 3.2.5.1. Intentional violations of this may result in disqualification.
- 3.2.6. Tele-operated Robots may NOT be in possession of any game components at the Start of a game.
- 3.2.7. Teams are not permitted to reach over any walls (exterior, interior, or the middle barrier).
- 3.2.8. NOTE: Competitors will participate in BOTH the "Maple Candy" game and the "On-site Autonomous Robot" challenge during BOTH competition days.

3.3. Game Play

- 3.3.1. Games will be played between 2 teams.
 - 3.3.1.1. Games will last 4 minutes.
 - 3.3.1.1.1. The amount of time between matches will depend on the number of teams participating. This information will be provided to teams at the start of the competition.
 - 3.3.1.1.2. Games will start on time. Teams are responsible to know when their games are scheduled. Teams arriving late will be allowed to use the remainder of the time in the game.
 - 3.3.1.1.3. Between games, battery changes and repairs to robots may be completed at the team's assigned "Pit Area Worktable", with appropriate PPE and Safety.
 - 3.3.1.2. It is a team decision what roles team members will fill.
 - 3.3.1.2.1. Drivers are the competitors holding the robot controller(s) and asserting direct control over a Tele-Operated robot.

- 3.3.1.2.2. The Spotter is the competitor providing navigational guidance to the driver.
 - 3.3.1.2.3. Competitors must remain in their designated driver zones at all times during a match.
 - 3.3.1.2.4. Competitors may change roles while a game is in progress.
 - 3.3.1.2.5. Competitors cannot enter onto the court surface or adjust their robot during a game.
- 3.3.2. Robots must remain in compliance with the rules in this document for the duration of the game.
- 3.3.2.1. Robots must start in their designated starting area, and in their designated starting position.
 - 3.3.2.1.1. The designated starting position is the same configuration used during the volume calculation.
 - 3.3.2.2. Damaging the court area is prohibited. If a robot's design causes damage to the court elements, then it will not be allowed to compete until it can operate without causing damage.
 - 3.3.2.2.1. Games missed due to this situation will be forfeited.
 - 3.3.2.2.2. Damage will be defined as any action that causes the court or components to no longer be able to function as intended.
 - 3.3.2.2.3. "Sapling's" are an element of play in the court, they may be knocked over and do not count as damage to the court.
 - 3.3.2.2.4. "Rocks" are an element of play in the court, made to make access difficult or tricky, they may be driven over, on etc, however intentional damage is prohibited.
 - 3.3.2.2.5. It is expected that all court components will be fixed firmly in place so that the court is a Neutral Factor in the competition.
 - 3.3.2.3. If a robot is mal-functioning and represents a hazard to participants, the court, other robots or itself, in the opinion of the NTC/Judge, then, the NTC/Judge may authorize shutting off the robot during a game. Disabled robots or parts of robots not generating any safety concerns will be left on the court until the game time expires.

- 3.3.2.4. Robots must not leave the contest court at any time during a game.
- 3.3.2.5. No aerial (flying) robots are permitted.
- 3.3.3. During game play, NTC/Judges will have ultimate authority over game rulings, and will have full authority over team conduct in the court area.
 - 3.3.3.1. It will be a NTC/Judge's ruling that decides if an 'End of the Game Component Placement' took place before or after the game-ending buzzer sounded.
 - 3.3.3.2. It will be a NTC/Judge's ruling that decides if the robot is in violation of the rules of the game.
 - 3.3.3.2.1. If any rule violations are noted during the competition, the following escalation pathway will be followed:
 - 3.3.3.2.1.1. During a match:
 - 1) 1st Warning. In match warning when noticed.
 - 2) 2nd Warning. In match warning when noticed, with the team clearly told the next occurrence is disqualification.
 - 3) Disqualification of the match. The team will then be subjected to a discussion with the judges. The team will have to prove the violation is addressed before they are allowed to proceed in another match.
 - 3.3.3.2.1.2. Not during a match (Practice time, inspection, or other)
 - 1) Discussion with the team about the violation noticed with the judges.
 - 2) Teams will not be permitted to proceed until the judges are convinced the violation is addressed.
 - 3.3.3.2.1.3. Note: Depending on the severity of the violation, warnings may be skipped.
- 3.3.4. Scoring will take place after the "End of Game" Buzzer.
- 3.3.5. If a piece falls out of the court, it may not be retrieved and will be considered out of the game for the remainder of the game time.

- 3.3.6. Should any game pieces fall into the opponent's court area, those pieces shall remain in play and usable by the opposing team.
 - 3.3.6.1. This applies to all game pieces which may count for points.
 - 3.3.6.2. Should a larger game piece fall into the opposing team's court, it may be removed at the Judge's/NTC discretion.
- 3.4. Teams will participate in a "Round Robin" followed by a "Seeded Double Elimination Playoff Tournament"
- 3.5. Teams will play an equal number of "Round Robin" games.
 - 3.5.1. Round Robin games will be played between 2 teams.
 - 3.5.2. Overall final placement of teams in the Round Robin will be determined using the win-loss-tie record.
 - 3.5.2.1. Match wins will be awarded 2 points.
 - 3.5.2.2. Match loses will be awarded 0 points.
 - 3.5.2.3. Match ties will be awarded 1 point.
 - 3.5.2.3.1. A tie is defined as a situation where 2 teams score identical points in a match.
 - 3.5.2.4. Round Robin ranking tie breaker will be determined by the following criteria:
 - 3.5.2.4.1. First tie-breaker will be the record of the tied teams against each other.
 - 3.5.2.4.2. Second tie breaker will be the total in-game points scored by the tied teams in all their matches.
 - 3.5.3. The "Trees" and "Saplings" in the forest area will be located as designated in the "Court Description" Appendix A as the "Round Robin Locations".
- 3.6. All teams will qualify for the "Seeded Double Elimination Playoff Tournament".
 - 3.6.1. Playoff Tournament seeding will be based on the results of the Round Robin.
 - 3.6.2. The "Trees" and "Saplings" in the forest area will be located as designated in the "Court Description" Appendix A as the "Tournament Locations".

4. Team's Area and Court Areas

4.1. The overall court playing surface will be a 16' by 16' square.

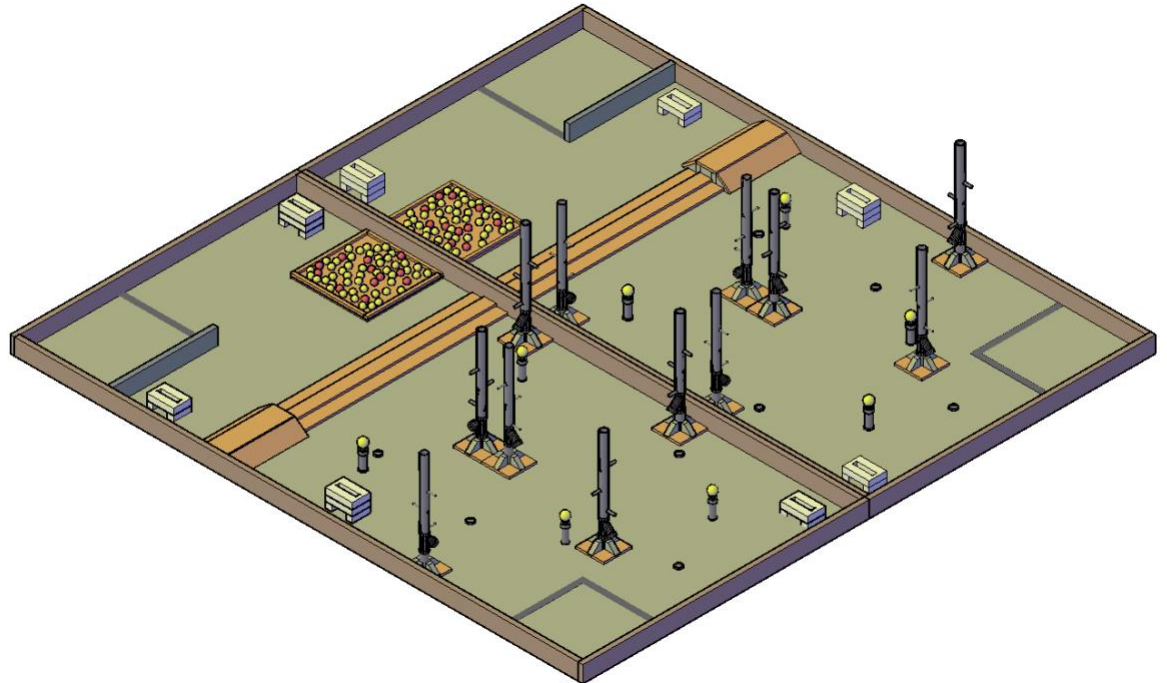

Figure: Overall Court

- 4.1.1. Exclusive use team spaces are 8' by 16' rectangles.
- 4.1.2. Perimeter court walls will be made using 2" by 6" planks. This will result in the walls being approximately 5.5" tall.
- 4.1.3. The court surface may vary between melamine, concrete, hardboard, plywood, or the facility floor.
- 4.1.4. Detailed court information has been included in the Appendix section of this document.
 - 4.1.4.1. Although great pains will be made to keep the court in compliance with the drawings, some inaccuracies in construction may occur. Please make your robot designs allowing for a possible $\frac{1}{2}$ inch tolerance.

4.2. Sugar Bush Area

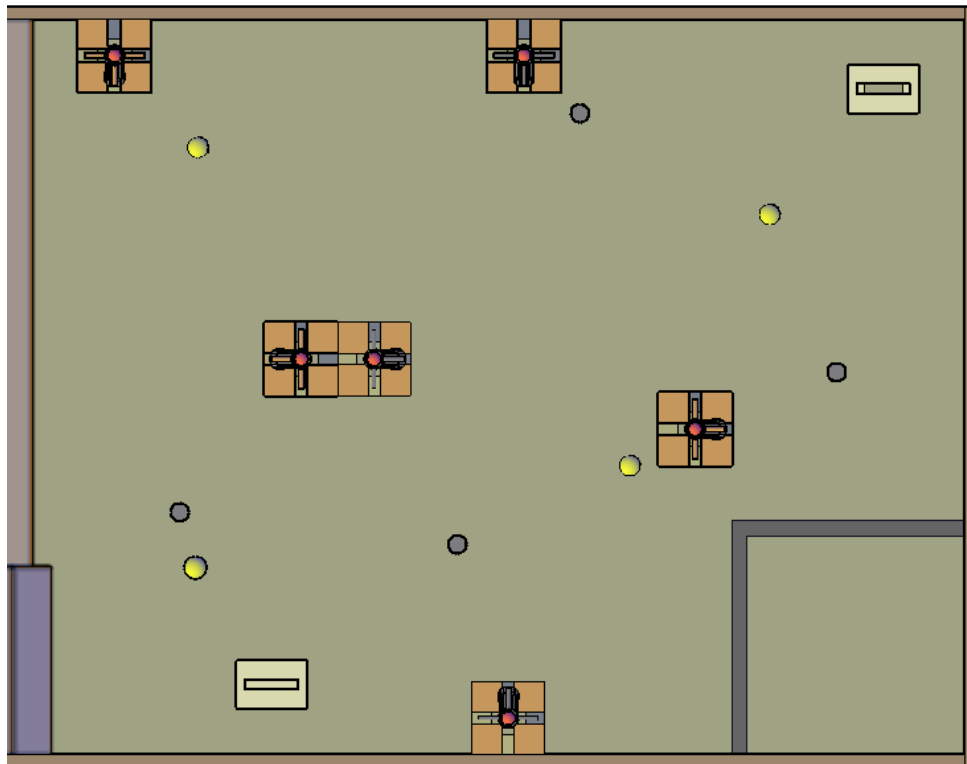

Figure: Sugar Bush Area

- 4.2.1. Located at one end of the court area within each team's exclusive use area there will be a "Sugar Bush Area".
- 4.2.2. The "Sugar Bush Area" will contain:
 - 4.2.2.1. 6 "Maple Trees"
 - 4.2.2.2. 4 "Saplings"
 - 4.2.2.3. 4 "Rocks"
 - 4.2.2.4. 2 "Snow Piles" starting locations
 - 4.2.2.5. Details on each item described below
- 4.2.3. The location of the "Maple Trees", "Saplings", and "Rocks" will have set locations.
 - 4.2.3.1. The location of these will be changed between the Round Robin and the Tournament.
 - 4.2.3.2. Detailed locations available in the Appendix A.
 - 4.2.3.3. These items will be secured to the court surface.
- 4.2.4. The "Snow Piles" will have set starting locations in the "Sugar Bush" as detailed in the Appendix A.
 - 4.2.4.1. One snow pile will be a "Short Snow Pile" and one snow pile will be a "Tall Snow Pile".

- 4.2.4.2. Details on the “Snow Piles” described below.
- 4.2.5. Teams will harvest the “Sap” from the trees in the “Sugar Bush Area”.
- 4.2.6. Teams should try not to knock over any of the “Saplings”.

4.3. Sugar Shack Area

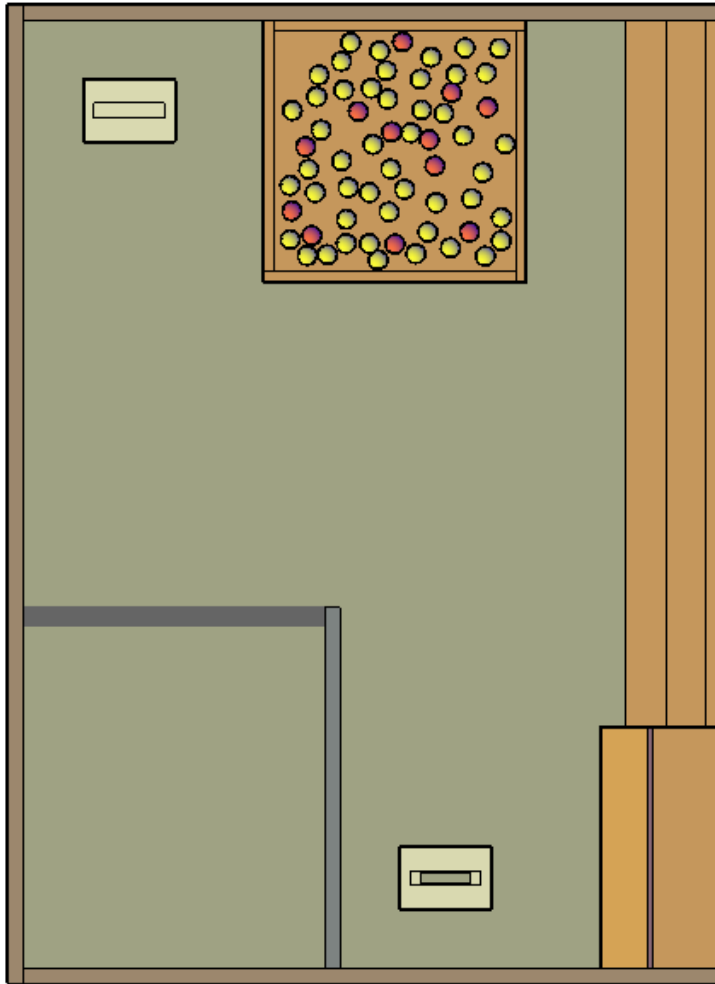

Figure: Sugar Shack Area

- 4.3.1. Each team's exclusive use area will contain a "Sugar Shack Area".
- 4.3.2. The "Sugar Shack Area" contains:
 - 4.3.2.1. 1 Sugar Shack Boiler
 - 4.3.2.2. "Maple Taffy Zone"
 - 4.3.2.3. 2 "Snow Piles" starting locations
- 4.3.3. The "Snow Piles" will have set starting locations in the "Sugar Shack Area" as detailed in the Appendix.

- 4.3.3.1. One snow pile will be a “Short Snow Pile” and one snow pile will be a “Tall Snow Pile”.
- 4.3.3.2. Details on the “Snow Piles” described below.
- 4.3.4. The “Sugar Shack Boiler” will be located on the middle barrier wall, 24 inches from the exterior court wall.
- 4.3.5. “Maple Taffy Zone” is an area within the “Sugar Shack Area” where teams will make the “Maple Taffy”

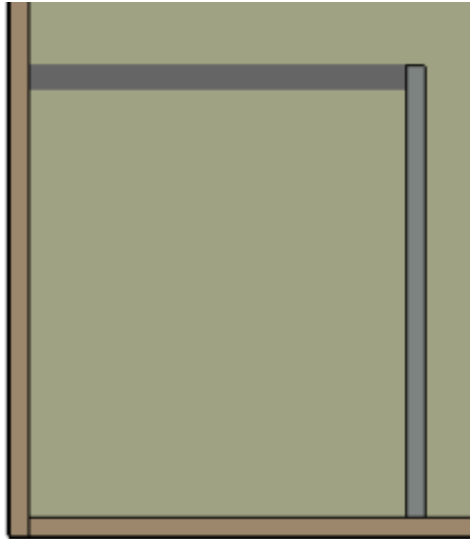

Figure: Maple Taffy Zone

- 4.3.5.1. This zone measures 30 inches wide by 36 inches in length.
- 4.3.5.2. This Zone is defined by a 36 inch long wall (constructed of a 2” by 6” plank) along one side, the exterior court walls along 2 sides, and a tape line along the 4th side. See court dimensions for full details.
 - 4.3.5.2.1. The defining planes are the interior limit of the walls and the vertical plane extending from the exterior edge of the tape line.
 - 4.3.5.2.2. Teams are not permitted to reach over the walls defining the “Maple Taffy Zone”

4.4. Hill Area

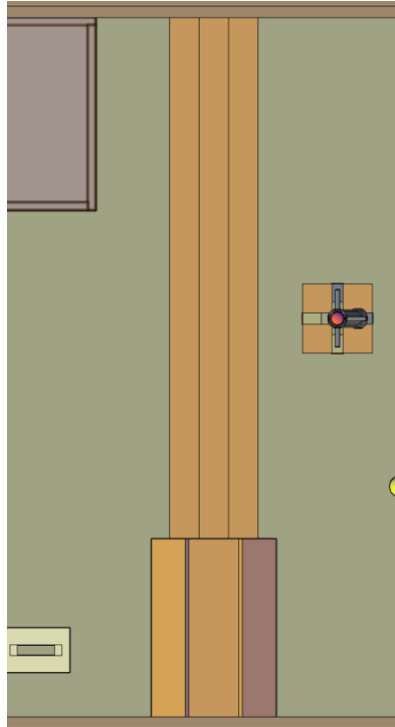

Figure: Hill Area

- 4.4.1. Separating the “Sugar Bush” from the “Sugar Shack Area” is the “Hill Area”.
- 4.4.2. The “Hill Area” extends across each team’s exclusive use area, from the middle barrier wall to the exterior wall.
- 4.4.3. Along the exterior wall, there is a 24 inch wide ramp section.
- 4.4.4. The remaining hill area is composed of a 2 tier-ed step section
 - 4.4.4.1. The base of the step section is a 12 inch wide $\frac{3}{4}$ inch plywood piece.
 - 4.4.4.2. The top step is a 4 inch wide $\frac{3}{4}$ inch plywood piece, centered on top of the base step piece.
 - 4.4.4.3. This results in 4 inch wide $\frac{3}{4}$ inch high steps.

4.5. Robots must start within the designated “Starting Area”

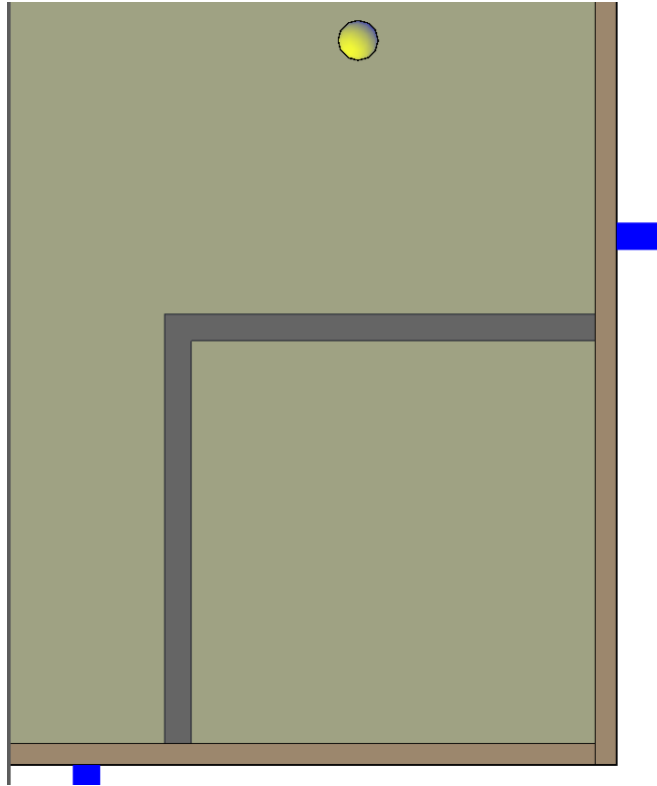

Figure: Tele-op Robot Starting Area

- 4.5.1. Tele-operated robot starting area is a 30 inch square located in the “Sugar Bush” in the corner of the exterior walls.
- 4.5.2. Optional Autonomous Element must start (and remain) within the “Sugar Shack Boiler”

4.6. Driver Zones

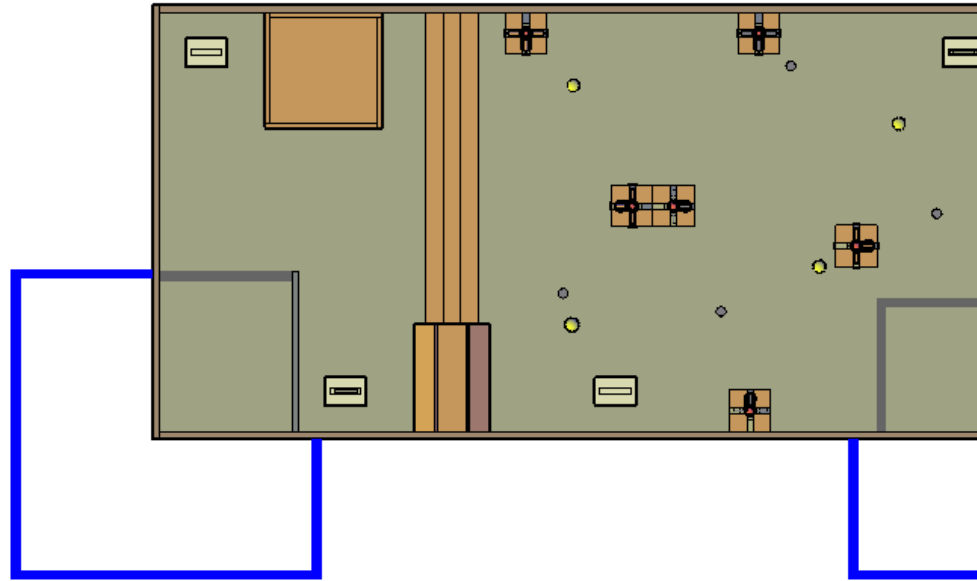

Figure: Driver Zones

- 4.6.1. Each driver or spotter must remain in their designated driver zone.
- 4.6.2. A maximum of one driver may occupy each driver zone.
- 4.6.3. Driver zones are located on the exterior corners of the court.
- 4.6.4. Each team has 2 designated driver zones.
- 4.6.5. No other competitors are permitted within 6' of the court.
- 4.6.6. See "Court Dimensions" in Appendix A for detailed dimensions.

5. Detailed Game Components

5.1. Sap Pieces

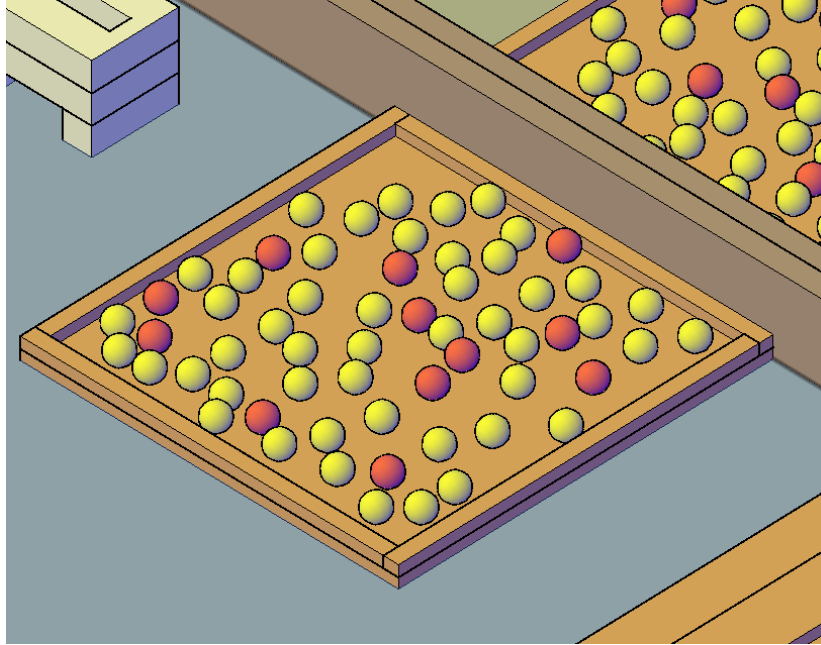

Figure: Sap Pieces

- 5.1.1. “Sap Pieces” are foam golf balls, measuring 1.68 inches in diameter.
- 5.1.2. There will be 2 types of “Sap Pieces”.
 - 5.1.2.1. Red “Sap Pieces” will represent “Maple Syrup”
 - 5.1.2.2. Yellow “Sap Pieces” will represent “Non-Maple Components” found in sap
- 5.1.3. Each court area will contain a total of 60 “Sap Pieces”
 - 5.1.3.1. There will be 12 “Maple Syrup” pieces
 - 5.1.3.2. There will be 48 “Non-Maple Components”
- 5.1.4. All “Sap Pieces” will begin the match inside of the “Tree” as described in the section below.

5.2. Maple Trees

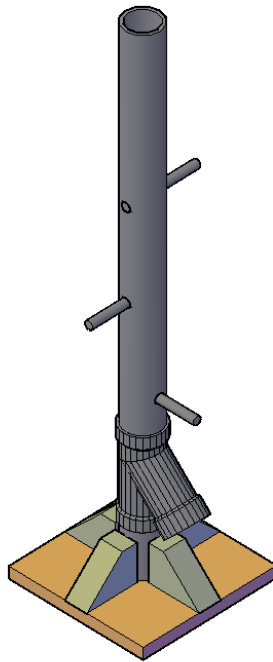

Figure: Maple Tree

- 5.2.1. Each “Sugar Bush” will contain 6 “Maple Trees”.
 - 5.2.1.1. The locations of the “Maple Trees” will change between the Round Robin and the Tournament.
 - 5.2.1.2. See “Court Dimensions” in Appendix A for specific locations.
- 5.2.2. “Maple Trees” are composed of:
 - 5.2.2.1. $\frac{3}{4}$ inch thick plywood base, measuring $9\frac{3}{8}$ ” x $9\frac{3}{8}$ ”
 - 5.2.2.2. 4 supports, which are 2x4 pieces of wood cut at a 45° angle
 - 5.2.2.3. 2” inner diameter ABS pipe. There will be a base piece and a top piece.
 - 5.2.2.4. 2” ABS 45° wye fitting, which will be called the “Spout”
 - 5.2.2.5. 3 dowel pegs, which are 5” in length and $\frac{1}{2}$ inches in diameter. These are called the “Taps”
 - 5.2.2.6. A 2x2 piece of wood cut at a 45° angle, to act as a block in the base ABS pipe
 - 5.2.2.7. Full details on the construction of the “Maple Trees” is available in the “Court Dimensions” in Appendix A
- 5.2.3. There are 2 types of “Maple Tree”
 - 5.2.3.1. The “Short Maple Tree” will have a base ABS pipe length of 4 inches, and an ABS pipe top piece of 26 inches in length.

- 5.2.3.2. The “Tall Maple Tree” will have a base ABS pipe length of 6 inches, and an ABS pipe top piece of 24 inches in length.
- 5.2.3.3. The resulting difference between the trees will only be the height of the “Spout”
- 5.2.4. Each tree will have 3 “Taps”.
 - 5.2.4.1. The “Taps” are ½ diameter dowel, which is 5 inches in length.
 - 5.2.4.2. The “Tap Holes” in the “Maple Tree” are 5/8 inch diameter, and extend through both sides of the ABS pipe, directly through the middle of the pipe.
 - 5.2.4.3. The lower “Tap” will be in line with the spout.
 - 5.2.4.4. The middle “Tap” will be at a 90° angle with the spout.
 - 5.2.4.5. The upper “Tap” will be at a 90° angle with the spout and a 180° angle with the middle “Tap”
 - 5.2.4.6. The “Tap Holes” will be drilled at:
 - 5.2.4.6.1. On the “Short Maple Tree”:
 - 5.2.4.6.1.1. Lower “Tap” will be located 3 inches from the bottom of the top ABS pipe piece (to the center of the hole).
 - 5.2.4.6.1.2. Middle “Tap” will be located 6 inches above the lower “Tap” hole (measured center to center)
 - 5.2.4.6.1.3. Upper “Tap” will be located 6 inches above the middle “Tap” hole (measured center to center)
 - 5.2.4.6.2. On the “Tall Maple Tree”:
 - 5.2.4.6.2.1. Lower “Tap” will be located 1 inch from the bottom of the top ABS pipe piece (to the center of the hole).
 - 5.2.4.6.2.2. Middle “Tap” will be located 6 inches above the lower “Tap” hole (measured center to center)
 - 5.2.4.6.2.3. Upper “Tap” will be located 6 inches above the middle “Tap” hole (measured center to center)
 - 5.2.4.6.3. The “Tap Heights” on all trees will be the same distance from the court surface.
 - 5.2.4.6.3.1. All “Lower Taps” will be at the same height from the court surface.
 - 5.2.4.6.3.2. All “Middle Taps” will be at the same height from the court surface.

5.2.4.6.3.3. All “Upper Taps” will be at the same height from the court surface.

5.2.4.7. The “Taps” will start with one end of the dowel piece lying flush to the ABS pipe surface, and the other end sticking out of the “Maple Tree”.

5.2.4.7.1. The “Lower Tap” will have the end sticking out facing the same direction as the spout.

5.2.4.7.2. The “Middle Tap” will have the end sticking out facing the left side of the tree (when looking at the tree from the side which the spout is facing)

5.2.4.7.3. The “Upper Tap” will have the end sticking out facing the right side of the tree (when looking at the tree from the side which the spout is facing)

5.2.4.8. Each “Tap” will hold a set amount of “Sap Pieces”.

5.2.4.8.1. The “Lower Tap” section of the “Maple Tree” will have 3 yellow “Sap Pieces”

5.2.4.8.2. The “Middle Tap” section of the “Maple Tree” will have 2 yellow “Sap Pieces” and 1 red “Sap Piece”, in the order of “Yellow - Yellow - Red” (bottom to top)

5.2.4.8.3. The “Upper Tap” section of the “Maple Tree” will have 3 yellow “Sap Pieces” and 1 red “Sap Piece” in the order of “Yellow - Yellow - Yellow - Red” (bottom to top)

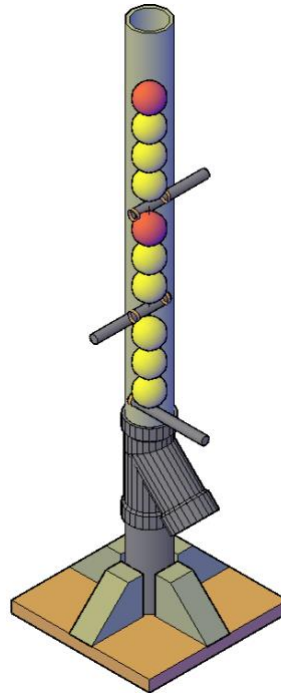

Figure: Maple Tree (Inside)

- 5.2.4.9. Pulling the “Tap” out of the tree will allow the “Sap Pieces” to fall down the inside of the “Maple Tree”
 - 5.2.4.9.1. Pulling the “Lower Tap” will allow the “Sap Pieces” to fall out of the spout.
 - 5.2.4.9.2. Pulling the “Middle Tap” or the “Upper Tap” will allow the “Sap Pieces” to fall within the tree, and onto any remaining pieces within the tree.
 - 5.2.4.9.2.1. To be specific: If a lower “tap” has not been removed, and a higher “tap” has been removed, then all the “Sap Pieces” would be resting on the lower “tap” that has not been removed.

5.3. Snow Piles

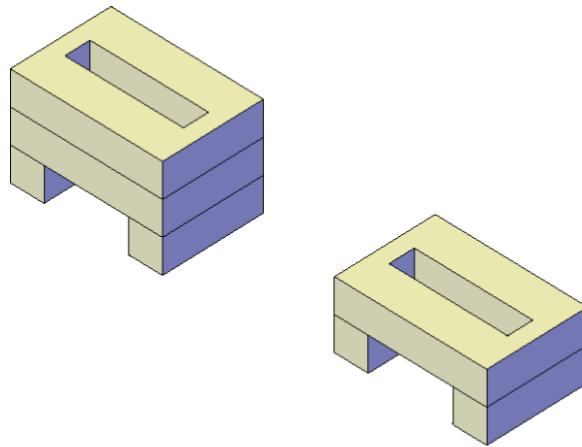

Figure: Snow Piles

- 5.3.1. There are 4 “Snow Piles” in this game.
- 5.3.2. “Snow Piles” are constructed using 2” thick rigid foam insulation, then covered in white duct tape.
- 5.3.3. There are 2 different types of “Snow Piles”
 - 5.3.3.1. The “Short Snow Pile” is constructed using 2 layers of rigid foam insulation.
 - 5.3.3.1.1. The bottom layer is composed of 2 pieces, 2 inches in width and 6 inches in length. They are positioned 5 inches apart.
 - 5.3.3.1.2. The top layer is composed of 1 piece, 9 inches in width and 6 inches in length.
 - 5.3.3.1.3. The top layer has a 1 inch wide, 7 inch long rectangular hole cut through the middle of it.
 - 5.3.3.1.4. See “Court Dimensions” in Appendix A for full details.
 - 5.3.3.2. The “Tall Snow Pile” is constructed using 3 layers of rigid foam insulation.
 - 5.3.3.2.1. The bottom layer is composed of 2 pieces, 2 inches in width and 6 inches in length. They are positioned 5 inches apart.
 - 5.3.3.2.2. The middle layer is composed of 1 piece, 9 inches in width and 6 inches in length.
 - 5.3.3.2.3. The top layer is composed of 1 piece, 9 inches in width and 6 inches in length.

- 5.3.3.2.4. The top layer has a 1 inch wide, 7 inch long rectangular hole cut through the middle of it.
- 5.3.3.2.5. See “Court Dimensions” Appendix for full details.
- 5.3.4. “Snow Piles” will start in their designated starting location.
 - 5.3.4.1. 2 “Snow Piles” will start in the “Sugar Bush”
 - 5.3.4.2. 2 “Snow Piles” will start in the “Sugar Shack Area”
 - 5.3.4.3. For detailed locations, see “Court Dimensions” Appendix.
 - 5.3.4.4. “Snow Piles” will start in these locations for all matches.
- 5.3.5. “Snow Piles” must be moved from their starting location to the “Maple Taffy Zone”.
 - 5.3.5.1. To be considered “inside of the Maple Taffy Zone” the “Snow Pile” must be completely within the zone, as defined by the vertical planes on the limits of the “Maple Taffy Zone” as described above.
 - 5.3.5.2. “Snow Piles” must be completely within the “Maple Taffy Zone” for the “Maple Syrup” pieces placed on them to form the “Maple Taffy” and be scored as such.

5.4. Sugar Shack Boiler

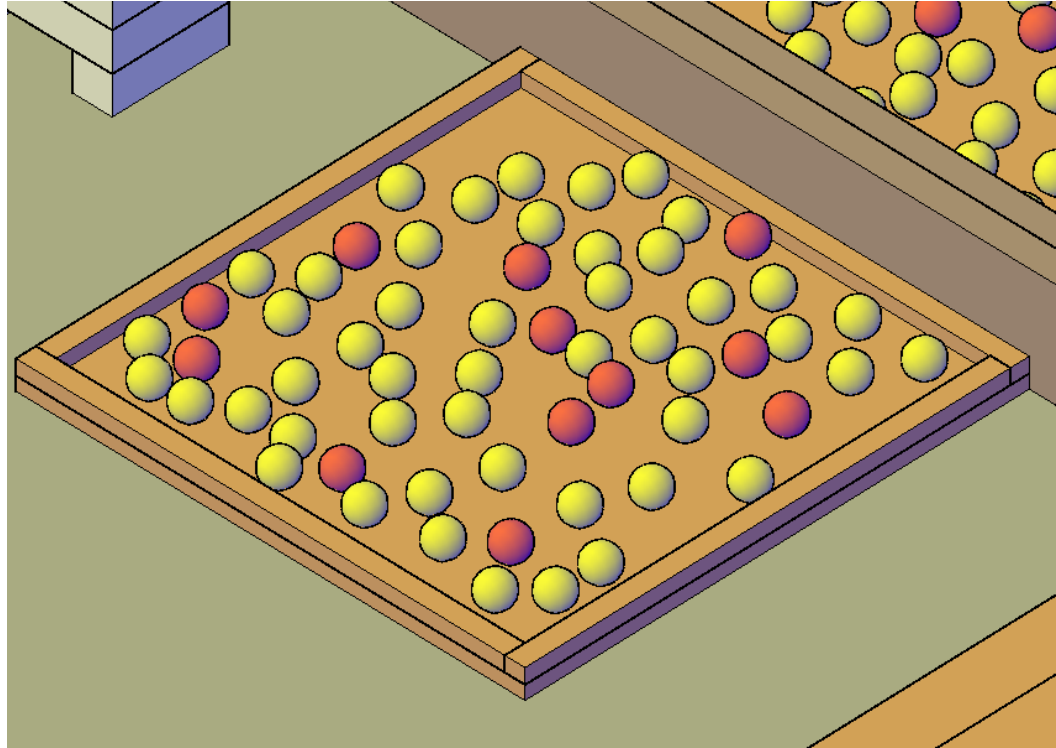

Figure: Sugar Shack Boiler

- 5.4.1. Each team will have access to a “Sugar Shack Boiler” within their “Sugar Shack Area”.
- 5.4.2. “Sugar Shack Boiler” will be composed of one 26 inch square piece of $\frac{3}{4}$ inch plywood as its base.
- 5.4.3. On top of the base, there will be a 1 inch wide strip of $\frac{3}{4}$ inch plywood along the exterior edge of the “Sugar Shack Boiler”.
- 5.4.4. The “inside” space in the “Sugar Shack Boiler” will be a 24 inch square.
- 5.4.5. A team’s optional “autonomous element” must remain inside the “Sugar Shack Boiler” at all times.
 - 5.4.5.1. The optional “autonomous element” is permitted to start within the “Sugar Shack Boiler”
 - 5.4.5.2. The optional “autonomous element” is not permitted to be outside of the “Sugar Shack Boiler”

5.5. Saplings and Rocks

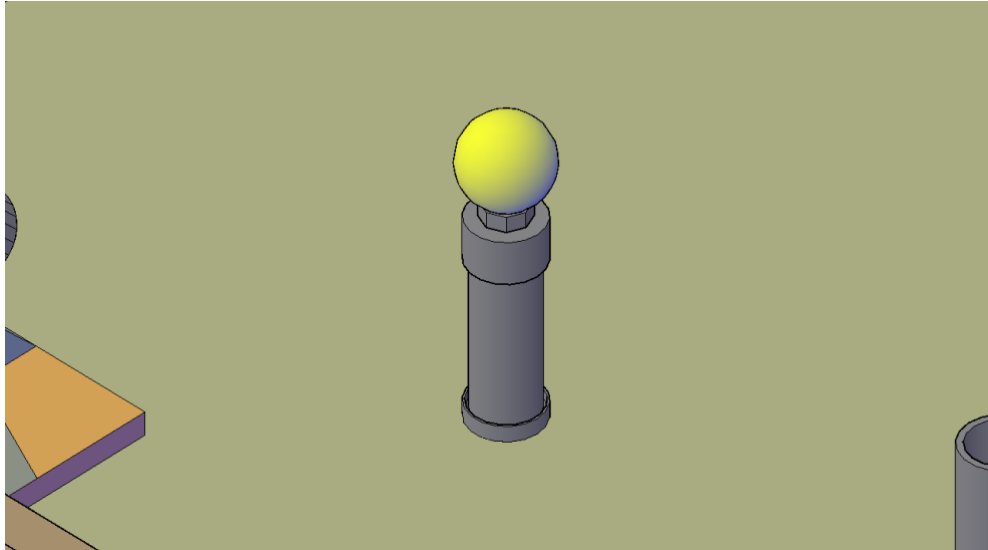

Figure: Sapling

- 5.5.1. Located within the “Sugar Bush”, there are 4 “Sapling” obstacles and 4 “Rock” obstacles.
- 5.5.2. Each “Sapling” consists of:
 - 5.5.2.1. A 6 inch long 1.5 inch diameter ABS pipe, capped on both ends. The caps used are identified in the parts list at the end of this document (with the court dimensions and parts).
 - 5.5.2.1.1. The top cap will remain unmodified.
 - 5.5.2.1.2. The bottom cap will be cut down to an internal height of $\frac{1}{2}$ inches.
 - 5.5.2.2. On the top of the ABS pipe, on top of the cap, there will be a 1 inch hex nut secured to the top. On top of the hex nut is where a standard tennis ball will sit.
 - 5.5.2.3. The cap on the bottom of the ABS pipe will be secured to the court surface. The ABS pipe will be fitted into this cap, but will be able to be knocked loose from the base cap.
 - 5.5.2.3.1. Knocking the ABS pipe from the cap onto the court surface will not be considered damage to the court.
 - 5.5.2.3.2. Any action by the robots which cause the secured cap to break away from the court surface may be considered damaging the court, and would be treated as such.
- 5.5.3. Each “Rock” consists of the same bottom caps as the “Sapling”.
 - 5.5.3.1. The cap will be secured to the court surface.

5.5.3.1.1. Any action by the robots which cause the secured cap to break away from the court surface may be considered damaging the court, and would be treated as such.

5.5.4. The “Saplings” and “Rocks” will switch places between the Round Robin and the Tournament.

5.5.4.1. See “Court Dimensions” Appendix for full details.

5.6. Additional Notes

5.6.1. At no time are teams permitted to intentionally reach over any wall.

5.6.1.1. Teams are not permitted to cross the middle barrier.

5.6.1.2. Teams are not permitted to cross the exterior walls.

5.6.1.3. Teams are not permitted to cross any interior walls.

5.6.2. At no time are teams permitted to intentionally pass game pieces over any walls.

5.6.3. Any game pieces which fall outside of the court area are no longer in play.

5.6.4. Should any game pieces fall into the opponent's court area, those pieces shall remain in play and usable by the opposing team.

5.6.4.1. This applies to all game pieces which may count for points.

5.6.4.2. Should a larger game piece fall into the opposing team's court, it may be removed at the Judge's/NTC discretion.

6. Maple Taffy Game Scoring Summary

6.1. All scoring will take place at the end of each 4 minute match.

6.1.1. All scores will be based on the location of things at the end of each match.

6.2. Snow Pile Scoring

6.2.1. For each “Snow Pile” delivered to the “Maple Taffy Zone”, 2 points will be awarded.

6.2.2. Each “Snow Pile” must be completely within the “Maple Taffy Zone” to be awarded points.

6.3. Sap Scoring

6.3.1. Every “Sap Piece” within the “Sugar Shack Boiler” at the end of the match will be awarded 1 point.

6.3.1.1. This includes all “Maple Syrup” pieces and all “Non-Maple Component” pieces.

6.3.1.2. Within the “Sugar Shack Boiler” is defined as within the 24 inch square defining the “Inside of the Sugar Shack Boiler”.

- 6.3.1.3. “Sap Pieces” are considered to be within this area as long as they are fully within the area, as defined by the vertical plane extending upward from the outside barrier of the “Sugar Shack Boiler”.
- 6.3.2. Every “Maple Syrup” piece on top of a “Snow Pile” within the “Maple Taffy Zone” will be awarded 2 points.
 - 6.3.2.1. If a “Snow Pile” is not fully within the “Maple Taffy Zone”, all “Maple Syrup” pieces on top of that “Snow Pile” will be awarded 0 points.
 - 6.3.2.2. “On top of” is defined as being fully supported by the top plane of the “Snow Pile”. This includes sitting in the cut out groove or sitting on top of the flat top surface.
 - 6.3.2.2.1. Balls which are rolling when the game time expires will be counted wherever they come to rest.
- 6.4. Sapling Scoring
 - 6.4.1. Competitors will be awarded points for each “Sapling” that remains intact.
 - 6.4.2. 1 point will be awarded for each “Sapling” still standing.
 - 6.4.2.1. A “Sapling” is considered standing if the ABS pipe is still standing within the secured cap.
 - 6.4.2.2. The “Sapling” does not need to be standing fully upright, as long as it is still in the secured cap and being supported by the secured cap.
 - 6.4.2.3. If the “Sapling” is touching the court surface, it will not be considered standing.
 - 6.4.3. 1 point will be awarded for each tennis ball which remains on top of the “Sapling”.
 - 6.4.3.1. The tennis ball is considered on top of the sapling if it is fully supported by the sapling.
 - 6.4.3.2. If the tennis ball is touching anything else, it will not be considered supported by the sapling.
 - 6.4.3.3. The “Sapling” Points will be awarded at the end of each match.
 - 6.4.4. If a “Sapling” or Tennis ball becomes knocked over during a match, it is considered knocked over.
 - 6.4.4.1. Competitors will not be allowed to rebuild these “Saplings”. Once they are knocked over, they are no longer eligible for points.

6.5. End of Match Location

- 6.5.1. Teams will be awarded 2 points if their tele-operated robots return to the starting zone.
 - 6.5.1.1. Robots must have fully left the starting zone at some point throughout the game to receive these points.
 - 6.5.1.2. Robots must be fully within the starting zone at the end of the match to receive these points.
 - 6.5.1.2.1. This means the robots must not break the vertical plane at the edge of the starting zone to gain these points.
- 6.5.2. 1 Additional point will be awarded to the team to fully complete the task and return to the starting zone in the fastest time during each match.
 - 6.5.2.1. A fully completed task is defined as:
 - 6.5.2.1.1. Delivering all “Non-Maple Components” into the “Sugar Shack Boiler”.
 - 6.5.2.1.2. All “Snow Piles” have been delivered into the “Maple Taffy Zone”.
 - 6.5.2.1.3. All “Maple Syrup” pieces have been delivered onto the top of the “Snow Piles” within the “Maple Taffy Zone”.
 - 6.5.2.1.4. All “Saplings” remain fully intact.

7. Pit Area and Court Access

- 7.1. Competitors **MUST** wear safety glasses when doing fabrication work involving material removal or adding processes (grinding, cutting, soldering, etc.).
- 7.2. Only registered competitors are permitted in the contest space.
- 7.3. Designated teacher/industry team advisors are permitted in the pit area only to inspect the worktable setup of their team prior to the start of the tournament.
 - 7.3.1. Designated teacher/industry team advisors are not permitted in the competition area during the competition.
 - 7.3.2. Teachers and industry advisors are not permitted to handle tools or robot parts.
 - 7.3.3. Students must effect all repairs and modifications on their robot.
- 7.4. A pit area is provided so that students may make repairs and improvements to their robots between games.

- 7.4.1. Teams will be provided with a pit area workspace on a standard project table. Depending on the number of teams and availability of space, teams may have to share a 60 by 30-inch table.
- 7.4.2. Teams must have a purpose built tabletop robot stand, designed to keep the robot wheels off the ground/tabletop surface regardless of orientation.
 - 7.4.2.1. This stand or these stands should hold the robot(s) securely and be capable of preventing the robot(s) from driving on or off the table in the case of either deliberate motor testing during repairs or due to random, unexpected motor activity.
- 7.4.3. A team's pit area must be kept safe at all times.
 - 7.4.3.1. This specifically means:
 - 7.4.3.1.1. Robots must be on the stand at all times when a battery is installed and connected to the robot
 - 7.4.3.1.2. Pit areas must be kept clean, tidy and free of all tripping hazards. Extension cords and power bars must all be taped, ziptied or velcro tied as per industry standards (minimum of 1 tie every 8 inches, must place 1 tie before and after every corner)
- 7.5. Teams **MUST** bring their robots, tools, and supplies into the skill area at Orientation. Teams are **NOT** allowed to remove their robots (or any part of their robots) from the skill area during the overnight periods between Orientation Day, Competition Day 1, and Competition Day 2 of the contest.
- 7.6. Laptops may be removed overnight by competitors.
- 7.7. Competitors are not permitted to be in the competition area during times which are not scheduled as competition times.
 - 7.7.1. This includes before the competition day begins, after the competition day ends, and during lunch.
 - 7.7.2. At no time is a competitor permitted to be in the competition area if NTC members are not present.

8. Robot Restrictions

- 8.1. Robots must remain in compliance with these rules throughout the competition. If teams fall out of compliance with these rules, then they will not be permitted to compete and will forfeit all their scheduled games until they have corrected the problem.
- 8.2. Start of Game Status
 - 8.2.1. Complete Team Entries must not exceed an overall size of 4 cubic feet (6912 cubic inches) at the start of each game.
 - 8.2.1.1. Total volume will be measured of the combined Tele-operated robots (in their starting position) volume plus the volume of the optional Independent Autonomous Element
 - 8.2.1.2. Team entries may expand to a larger size once a game has started.
 - 8.2.2. Robots must start within their designated starting area.
 - 8.2.2.1. Tele-operated Robots must start together completely within the “Tele-operated Robot Starting Area”, as described in Section 4.5
 - 8.2.2.2. The optional Independent Autonomous Element may start in the “Designated Autonomous zone”, as described in Section 4.5
 - 8.2.3. When a Tele-operated Robot’s main power is turned on prior to the start of a game, the robot must be in an overall “Idle State”, and the following conditions must exist:
 - 8.2.3.1. They must be stationary
 - 8.2.3.2. They must not be in possession of any game pieces
 - 8.2.4. All systems may be turned ON
 - 8.2.5. Air System Circuits may be fully charged to 100 PSI, and their compressors can be ON
- 8.3. During Game Status
 - 8.3.1. Robots may expand beyond the starting volume once the game begins.
 - 8.3.2. A team’s Robots must remain in their designated areas for the duration of the game.
 - 8.3.2.1. All Robots must remain in their own team’s court.
 - 8.3.2.2. All Tele-operated Robots are permitted to access any area within the team’s exclusive use area (in compliance with all other rules).

- 8.3.2.3. The team's Optional Autonomous Element must remain in the "Designated Autonomous Zone" for the duration of the game.
- 8.3.3. Strategies aimed at preventing the opponent from playing the game are not permitted, as they are not in the spirit of fair play, and will not be permitted.
- 8.4. Each team's optional Autonomous Element must not have any direct interaction with the competitors.
- 8.5. All Robots must conform to all of the following safety requirements.
 - 8.5.1. All Robots (Tele-operated and Autonomous) must be able to be shut off with a single motion.
 - 8.5.1.1. The "Kill Switch" must be easily accessible.
 - 8.5.1.2. The "Kill Switch" must be securely mounted.
 - 8.5.1.3. Robot controller receivers may be in an independent circuit.
 - 8.5.2. Robot power sources and circuits must follow the following requirements:
 - 8.5.2.1. The maximum continuous power rating allowed in any circuit branch is 240 Watts, which will be limited by voltage and fuse selection.
 - 8.5.2.1.1. To calculate power in any given circuit, use the following formula: $\text{Power (Watts)} = \text{Voltage (Volts)} \times \text{Current (Amps)}$
 - 8.5.2.2. The total voltage in any individual circuit cannot exceed 24 Volts.
 - 8.5.2.3. Each current branch path from the battery must include either an in-line fuse, resettable fuse, circuit breaker, or be connected to a dedicated fuse in a rack.
 - 8.5.2.3.1. Systems which utilize a built in fuse will be considered to have this requirement met, as long as:
 - 8.5.2.3.1.1. It is a known and documented system. If the system is unknown to the NTC, teams may be required to produce this documentation.
 - 8.5.2.3.1.2. There are no modifications made to the system.
 - 8.5.2.3.1.3. There are no external circuits which do not contain a fused circuit. Proper fuses are required for modified circuits

- 8.5.2.4. Batteries must meet the following requirements:
 - 8.5.2.4.1. All batteries must be a complete sealed commercial battery pack.
 - 8.5.2.4.2. All batteries must be securely mounted to the robot.
 - 8.5.2.4.3. Batteries wired in series should be the same amp hour rating (ex. both 1500 mAh) and batteries in parallel are of same voltage (ex. both 12 volts).
- 8.5.3. Robots utilizing non-electrical energy sources must meet the following requirements:
 - 8.5.3.1. Pneumatic systems are permitted, with the following restrictions:
 - 8.5.3.1.1. Pneumatic based energy sources may be pre-charged to a maximum of 100-PSI pressure in their reservoirs (cylinders) at the start of each game.
 - 8.5.3.1.2. Pneumatic systems using Competitor-made or modified air pressure hardware are NOT permitted.
 - 8.5.3.1.3. All pressurized tanks on robots must have a pressure gauge to indicate the stored pressure and a form of automatic overpressure safety relief system.
 - 8.5.3.1.4. The pressure tanks and related gauges / controls must be shielded from damage due to collisions or flying target objects.
 - 8.5.3.1.5. The stored pressure in the tank must not exceed a maximum of 100 PSI at any time.
 - 8.5.3.2. Tension-based energy sources (elastics, springs or other) may be in either a relaxed at rest state or in a tense / compressed state at the start of each game.
- 8.5.4. The following devices are not permitted:
 - 8.5.4.1. No explosive materials of any kind may be used (ether, gunpowder, acetylene etc.).
 - 8.5.4.2. Laser devices are not permitted.
 - 8.5.4.3. Hydraulic fluid systems are not permitted.
- 8.6. Teams must use an appropriate Robot Controller.
 - 8.6.1. It is recommended (not required) that all teams use 2.4 GHz “non-crystal” control systems on Tele-operated Robots.
 - 8.6.2. Teams are allowed the use of an unlimited number of channels, but only two separate tele-operated robots.

- 8.6.2.1. Teams assume full responsibility if any interference is to occur with their respective communication systems that could render the robot(s) useless.
- 8.6.3. Robots may not transmit audio/visual information to the robot devices. (Ex: Having a camera transmit images real time to a computer near the driver, etc.)

9. Inspection

- 9.1. All Robots must pass a pre-competition inspection for compliance with the safety and design rules before they will be allowed to participate in games.
 - 9.1.1. If any modifications are made on a Robot during the competition, the Robots may be subjected to an additional inspection for compliance before being permitted to participate in games.
 - 9.1.2. All robots must be inspected, including the Tele-operated robots and Autonomous robots in a team's entry.
- 9.2. It is the purpose of the inspection to ensure teams and all robots are in compliance with the rules and restrictions described in this document.
- 9.3. Team entries will be measured for total combined volume.
 - 9.3.1. All robots will be measured in their starting positions.
 - 9.3.1.1. Tele-op robots must start together, and will be measured together.
 - 9.3.1.2. Optional Autonomous element will be measured separately, in their starting position.
 - 9.3.2. Volume of the robots will be calculated using the maximum length, width, and height of the entry, using the formula $V = LWH$

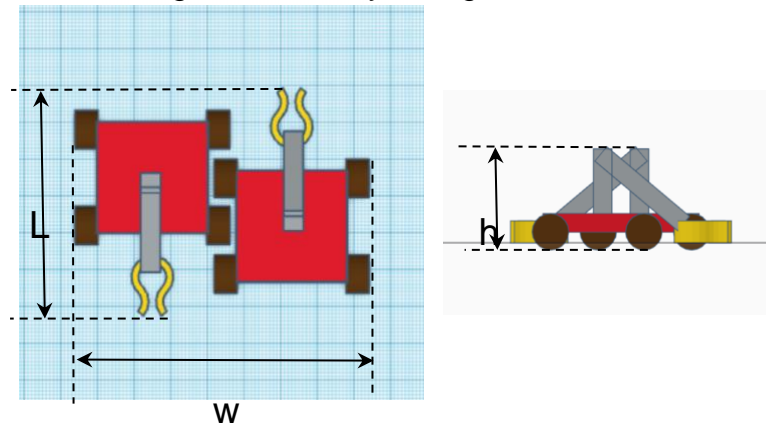

Figure: Volume Measurement

- 9.4. Teams will be required to demonstrate the operation of their robots as part of the inspection.
 - 9.4.1. A demonstration of a team's robot entry (or entries) must show the functionality of the robot to play the game.
 - 9.4.2. All robots must be shown to be in full compliance with the rules of the game, as described in this document.
 - 9.4.2.1. Should any clarification document be made, it will also be considered as part of this document.
- 9.5. All team's and robots must abide by all safety requirements.
 - 9.5.1. All robots must have a wiring diagram.
 - 9.5.1.1. Acceptable examples of wiring diagrams are available in the Appendix.
 - 9.5.2. All robots must have a method of shutting the robot with a single motion. For the purposes of this document, this will be called a "kill switch".
 - 9.5.2.1. The "kill switch" must be easily accessible.
 - 9.5.2.2. The robots must be able to be safely turned off, without risk to anyone.
 - 9.5.3. All teams must have a Safety Data Sheet available (physically on hand) for all chemical based components.
 - 9.5.3.1. This includes all batteries, as well as any other component that may be chemical based.
 - 9.5.4. All batteries must be in good working condition.
 - 9.5.4.1. Batteries must be complete sealed commercial battery packs.
 - 9.5.4.2. Batteries must be securely mounted.
 - 9.5.4.2.1. Securely mounted is defined as not able to be knocked off of the robot in any manner of regular gameplay.
 - 9.5.4.3. Batteries wired in series should be the same amp hour rating.
 - 9.5.4.4. Batteries wired in parallel should be the same voltage.
 - 9.5.5. All teams must have a tabletop robot stand for their robots.
 - 9.5.5.1. This stand or these stands should hold the robot(s) securely and be capable of preventing the robot(s) from driving on or off the table in the case of either deliberate motor testing during repairs or due to random, unexpected motor activity.
 - 9.5.6. All robots will be inspected to ensure all parts are permitted parts.

- 9.5.6.1. Should any non-permitted part be detected, teams will be required to remove them before being allowed to compete.

- 9.5.7. The maximum continuous power rating allowed in any circuit branch is 240 Watts, which will be limited by voltage and fuse selection. Power will be calculated using the formula $\text{Power} = \text{Voltage} \times \text{Current}$
 - 9.5.7.1. The total voltage in any circuit cannot exceed 24 Volts.
 - 9.5.7.2. Each current branch path from the battery must include either an in-line fuse, resettable fuse, circuit breaker, or be connected to a dedicated fuse in a rack.
 - 9.5.7.2.1. It is the purpose of a fuse/breaker to protect competitors and the equipment in their circuits.
 - 9.5.7.2.2. Systems which utilize a built in fuse will be considered to have this requirement met, as long as:
 - 9.5.7.2.2.1. It is a known and documented system. If the system is unknown to the NTC, teams may be required to produce this documentation.
 - 9.5.7.2.2.2. There are no modifications made to the system.
 - 9.5.7.2.2.3. There are no external circuits which do not contain a fused circuit.

- 9.5.8. Any teams using pressure-based systems must ensure:
 - 9.5.8.1. No Competitor-made or modified air pressure hardware is being used.
 - 9.5.8.2. Only commercially manufactured pressure tanks (cylinders) can be used.
 - 9.5.8.3. Pressure in tanks does not exceed 100 PSI
 - 9.5.8.4. Systems have an over-pressure safety valve
 - 9.5.8.5. Pressure tanks and related gauges and controls are shielded from damage due to collisions
 - 9.5.8.6. Pressure system circuit diagram is provided
- 9.5.9. All teams must have eye protection available.
- 9.5.10. All teams must wear eye protection when working on their robots.
- 9.5.11. All teams' pit areas must be kept tidy and free from safety concerns.

10. Autonomous Competition Overview

- 10.1. Competitors will be provided, at no cost to the teams, with a kit distributed to them through their provincial/Territorial office.
- 10.2. The designated autonomous robot chassis (see Appendix D) may be pre-built.
 - 10.2.1. All other autonomous components must be disassembled upon the beginning of Competition Day 1.
 - 10.2.2. Teams choosing not to use the designated autonomous robot chassis may do so. However, the only chassis permitted to be pre-built is the designated autonomous robot chassis, as chosen and approved by the NTC.
- 10.3. A description of the Competition Component Collection will be posted on the Skills/Compétences Canada Website.
- 10.4. Competitors will demonstrate their robot's performance in a court to be defined at the Skill area.
- 10.5. At the orientation meeting, Competitors will be told the specific Robot Behaviors their Built On-Site Robots need to complete.
 - 10.5.1. During this time, teams will also be informed of the Autonomous Challenge marking system.
- 10.6. The suggested performance items listed below reflect the type of core isolated robot performance elements competitor robots will need to complete
 - 10.6.1. Follow wall perimeter,
 - 10.6.2. Navigate a maze,
 - 10.6.3. Navigate around obstacles,
 - 10.6.4. Follow a colored tape line on the floor,
 - 10.6.5. Locate and touch an object
 - 10.6.6. Pick up a small object and move it to a new location
- 10.7. Competitors MUST understand the list above represents Samples ONLY and does not present a final or complete list of the potential robot behaviors they might be asked to create.
- 10.8. Teams need to develop an understanding of the performance capabilities of ALL components in the Competition Collection and prepare to be able to use any of these components effectively.
- 10.9. Competitors need to be prepared to go beyond the initial single stage performance requirements to multi-stage performance requirements as the culminating end of the competition experience.
- 10.10. Build On-Site Autonomous Tasks Equipment:

- 10.10.1. Competitors will be required to build their autonomous robot solutions using ONLY the contents of the kit provided.
- 10.10.2. If a Robot Component is not provided in the common to all "Box of Component's" then it cannot be installed on the Competitor's Autonomous Robot.
- 10.10.3. Exception List to "Only what is in the box"
 - 10.10.3.1. Laptop/Computer, mouse, and keyboard, power cord, usb cable, software drivers
 - 10.10.3.2. Sample code, Arduino IDE or similar program
 - 10.10.3.3. Measuring tape, allen keys, small wrench or pliers
 - 10.10.3.4. Paper, pen, pencil, calculator to record measurement
 - 10.10.3.5. Replacement parts for the originals ie. Cable ties
 - 10.10.3.6. Large and/or small storage containers
- 10.11. Teams will have time periods where they have shared access to the various Autonomous Performance Court Environments to conduct their Task Solution / Preparation Activities
- 10.12. Teams will have a select number of Marked Attempts at each of the Autonomous Performance Tasks as time permits. The number of attempts will be predetermined at the start of the competition.
- 10.13. Marked Autonomous Task Attempts will be conducted on a "By the request of the Teams Basis" with a requirement that Teams complete ALL Autonomous Task Preparation Activities by an announced at the start of the competition Fixed Time: Example: All Autonomous Task Preparation Activities must end by 3:45 PM on Competition Day 2.

11. Medal Awarding System

- 11.1. Medals will be awarded based on Tele-operated game (Round Robin and Playoff Tournament), Autonomous task, and Safety.
- 11.2. The overall score will be determined by combining the points awarded in each section of the competition.
 - 11.2.1. Tele-operated Round Robin points will be awarded based on overall standing during the Round Robin.
 - 11.2.1.1. Round Robin points will be awarded in the following manner:

Place	1st	2nd	3rd	4th	5th	6th	7th	8th	9th	10th	11th	12th	13th
Points	29	27	25	23	21	19	17	15	13	11	9	7	5

- 11.2.2. Tele-operated Playoff Tournament points will be awarded based on final tournament placement.
 - 11.2.2.1. Tele-operated Playoff Tournament points will be awarded in the following manner:

Place	1st	2nd	3rd	4th	5th	6th	7th	8th	9th	10th	11th	12th	13th
Points	30	27	24	21	19	17	15	13	11	9	7	5	3

- 11.2.3. Autonomous task points will be awarded based on the Autonomous task.
- 11.2.4. Safety points will be awarded based on the safety criteria listed in the Appendix E
- 11.3. Overall score will be 59% Tele-operated game performance, 39% Autonomous task performance, and 2% Safety score.
- 11.4. Medals will be awarded based on the overall team scores. The Gold Medal will go to the team with the highest overall score, the Silver to the next highest overall score, and the Bronze to the next highest after that.
 - 11.4.1. In the case that a tie occurs in the Overall Team Scores, the medal will go to the team with the higher Autonomous Task Score.



Appendix A: Court Dimensions and Details

Separate document posted on our website.

Appendix B: Tele-operated Main Game Score Sheet

Separate document posted on our website.

Appendix C: Sample Wiring Diagrams

Separate document posted on our website.

Appendix D: Approved Autonomous Challenge Chassis Optional Pre-build

Separate document posted on our website.

Appendix E: Safety Criteria and Scoresheet for Judging

Separate document posted on our website.

Appendix F: Inspection Sheet

Separate document posted on our website.